



AD-4545 Service Manual

American Dryer Corporation
88 Currant Road
Fall River, MA 02720-4781
Telephone: +1 (508) 678-9000 / Fax: +1 (508) 678-9447
E-mail: techsupport@amdry.com

www.amdry.com

Retain This Manual in a Safe Place for Future Reference

This product embodies advanced concepts in engineering, design, and safety. If this product is properly maintained, it will provide many years of safe, efficient, and trouble free operation.

Only qualified technicians should service this equipment.

OBSERVE ALL SAFETY PRECAUTIONS displayed on the equipment or specified in the installation manual included with the dryer.

The following "FOR YOUR SAFETY" caution must be posted near the dryer in a prominent location.

FOR YOUR SAFETY

Do not store or use gasoline or other flammable vapors and liquids in the vicinity of this or any other appliance.

POUR VOTRE SÉCURITÉ

Ne pas entreposer ni utiliser d'essence ni d'autres vapeurs ou liquides inflammables à proximité de cet appareil ou de tout autre appareil.

We have tried to make this manual as complete as possible and hope you will find it useful. The manufacturer reserves the right to make changes from time to time, without notice or obligation, in prices, specifications, colors, and material, and to change or discontinue models. The illustrations included in this manual may not depict your particular dryer exactly.

IMPORTANT

For your convenience, log the following information:

DATE OF PURCHASE _____ MODEL NO. AD-4545

RESELLER'S NAME _____

SERIAL NUMBER(S) _____

Replacement parts can be obtained from your reseller or the ADC factory. When ordering replacement parts from the factory, you can FAX your order to ADC at +1 (508) 678-9447 or telephone your order directly to the ADC Parts Department at +1 (508) 678-9000. Please specify the dryer model number and serial number in addition to the description and part number, so that your order is processed accurately and promptly.

"IMPORTANT NOTE TO PURCHASER"

Information must be obtained from your local gas supplier on the instructions to be followed if the user smells gas. These instructions must be posted in a prominent location near the dryer.

IMPORTANT

You must disconnect and lockout the electric supply and the gas supply or the steam supply before any covers or guards are removed from the machine to allow access for cleaning, adjusting, installation, or testing of any equipment per OSHA standards.

Please observe all safety precautions displayed on the equipment and/or specified in the installation manual included with the dryer.

CAUTION

Dryer(s) should never be left unattended while in operation.

“Caution: Label all wires prior to disconnection when servicing controls. Wiring errors can cause improper operation.”

«Attention: Au moment de l'entretien des commandes, étiquetez tous les fils avant de les débrancher. Des erreurs de câblage peuvent entraîner un fonctionnement inadéquat et dangereux.»

WARNING

Children should not be allowed to play on or near the dryer(s). Children should be supervised if near dryer(s) in operation.

Under no circumstances should the dryer door switch(es), lint door/drawer switch(es), or heat safety circuit(s) ever be disabled.

The dryer must never be operated with any of the back guards, outer tops, or service panels removed. Personal injury or fire could result.

The dryer must never be operated without the lint filter/screen in place, even if an external lint collection system is used.

FOR YOUR SAFETY

Do not dry mop heads in the dryer. Do not use dryer in the presence of dry cleaning fumes.

The dryers must not be installed or stored in an area where it will be exposed to water and/or weather.

The wiring diagram for the dryer is located in the front electrical control box area.

Table of Contents

Parts Locations and Removal	4
Computer Panel Assembly Removal	4
Computer Board Removal	4
Lint Drawer Removal	4
Door Switch Removal	5
Top or Bottom Front Panel Removal	5
Lint Door Switch Removal	5
Burner Hi-Limit Removal	6
Idler Arm Removal	6
Main 18" Pulley Removal	6
Temperature Sensor/ Basket Hi-Limit Removal	6
Sail Switch Removal	7
Ignitor Probe Assembly Removal	7
Flame-Probe Removal	7
Rotation Sensor Removal	8
Basket/Tumbler Support Removal	8
Check Tumbler Lateral and Vertical Adjustments	8
Tumbler Alignment (Lateral)	9
Motor/Impellor Removal	9

List of Acronyms

DSI	Direct Spark Ignition
OSHA	Occupational Safety and Health Administration

Parts Locations and Removal _____

NOTE: Disconnect power to the machine at all times before removing or installing any components!

Computer Panel Assembly Removal:

Remove the four screws holding the computer panel to the dryer. Lift up on the panel and pull out the computer panel assembly.

Slide the bottom of the panel that is notched through the two metal buttons to hold the panel on the dryer.

At this point you can disconnect the connectors that are on the boards and totally remove the complete panel from the dryer by sliding in the panel to where it's over the two metal buttons and lifting it up.



Computer Board Removal:

Follow instructions for computer panel removal. Disconnect all connectors connected to the board.

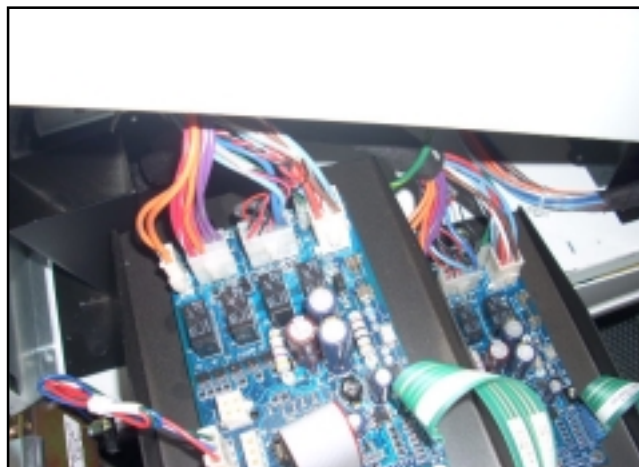

Remove the two Phillips head screws in two of the corners of the computer board and pull the board off of the standoffs on the other two corners.

Lint Drawer Removal:

Unlock the lint drawer (if equipped with a lock) pull out the lint drawer 3/4 out, under the lint drawer is a rocker type locking mechanism push up on one end of this rocker type lock and remove it completely.



Door Switch Removal:

Open the main door. Remove the two Phillips head screws attaching the door switch housing to the front panel.



Disconnect the two wires on the door switch. Remove the two Phillips head screws (and associated nuts and star washers) holding the door switch to the door switch housing.



Top or Bottom Front Panel Removal:

Top Panel: Remove the lint drawer. Remove the computer panel assembly. Remove the ten screws holding the panel to the dryer. Lift up and pull out the panel about 8-inches or so.

Disconnect the door switch wires (blue wires) from the connector, connected to the connector on the side of the wrapper. Totally remove the panel from the dryer.

Bottom Panel: Remove the lint drawer. Remove the ten screws (this is the bottom only) on the front panel. Lift up and pull out the panel about 8-inches or so. Disconnect the door switch wires (blue wires) from the connector, connected to the connector on the side of the wrapper. Totally remove the panel from the dryer.



Lint Door Switch Removal:

Remove the lint drawer. Remove the two screws that are holding the lint door switch, pull out the lint switch, disconnect the two wires on it. Replace the switch.



Burner Hi-Limit Removal:

Remove top or bottom back guard panel. Remove the two red wires on the burner hi-limit switch. Remove the two screws holding the burner hi-limit switch to the dryer. Remove the hi-limit switch.



Idler Arm Removal:

Loosen the two 9/16" bolts holding the idler arm to the machine. Remove the two belts. Remove those two 9/16" bolts the idler arm will now come away from the machine. Take off the idler pulley by loosening the two setscrews on the idler pulley and pull it off the idler shaft.

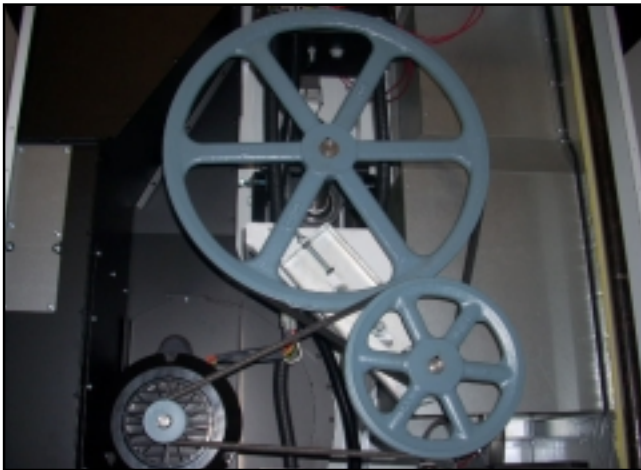

Main 18" Pulley Removal:

Remove top or bottom back guard panel. Loosen the two 9/16" bolts on the idler arm. Note position of the arm for reinstallation.

Remove the upper 18" pulley belt. Loosen the two setscrews on the 18" main pulley.

Remove the pulley. Install new pulley in reverse make sure the setscrews on the new 18" pulley are tight.

Temperature Sensor/ Basket Hi-Limit Removal:



Remove the lint screen (see instructions on lint screen removal).

Remove the three hex head screws holding the temperature sensor bracket to the lint screen rail.

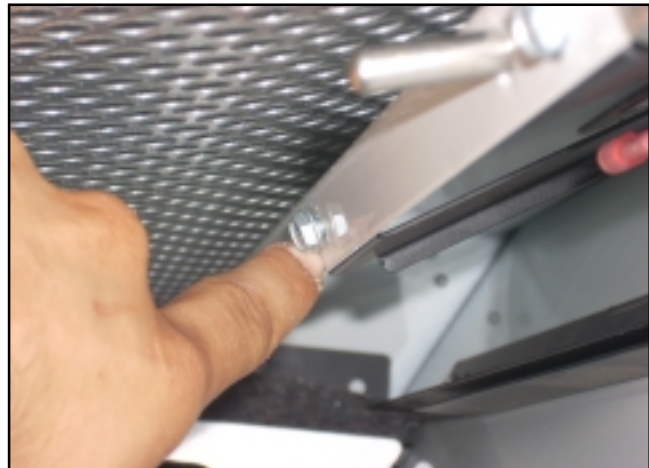

Disconnect the 4 Pin connector from the bracket.

Remove the bracket assembly from the machine.

At this point you can remove the basket hi-limit by removing the two screws and nuts and washers holding it in place.

Also, disconnect the two wires going to the hi-limit.



Sail Switch Removal:

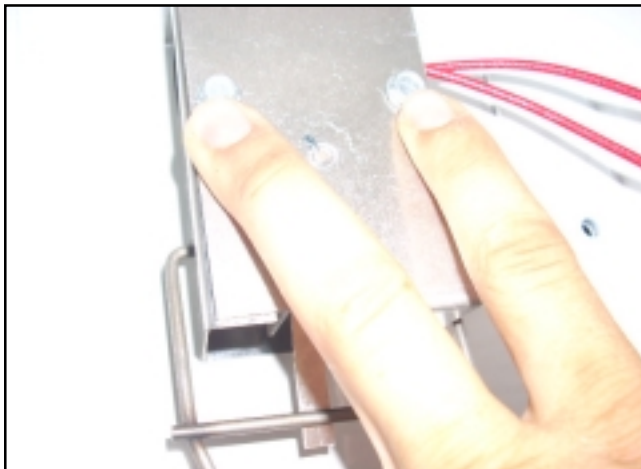
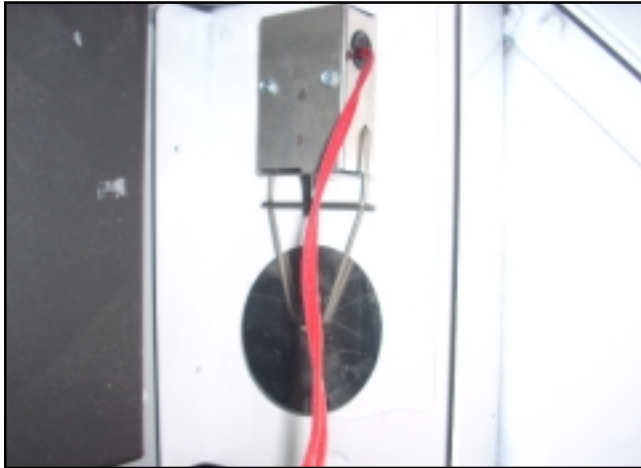

Remove the back guard. As shown in picture remove the two hex head screws.

The sail switch box assembly will now come apart in two pieces.

Remove the screws/nuts associated with the sail switch and remove it from the bracket.

Ignitor Probe Assembly Removal:

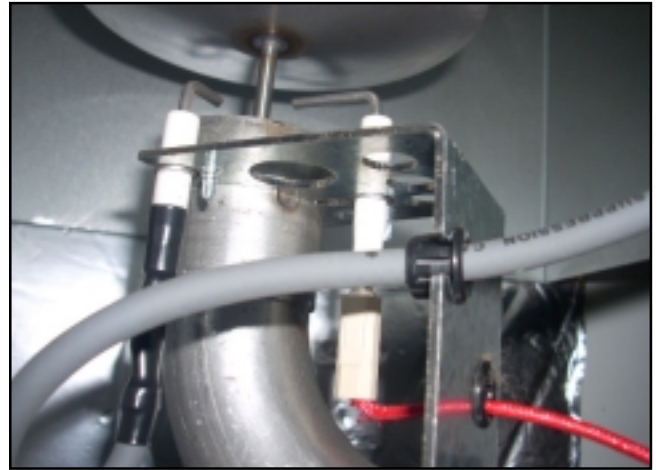

Remove the back guard, disconnect the orange boot from the DSI module by simply pulling off.



Remove the one Phillips head screw that is holding the ignitor probe to the ignitor bracket.

Remove black plastic ring protector from the ignitor bracket and remove ignitor and wire from the machine.

Flame-Probe Removal:



Remove the back guard, disconnect the white single connector on the flame-probe.

Remove the one Phillips head screw on top of the ignitor bracket holding the flame-probe. Pull the probe up and out of the machine.

Rotation Sensor Removal:

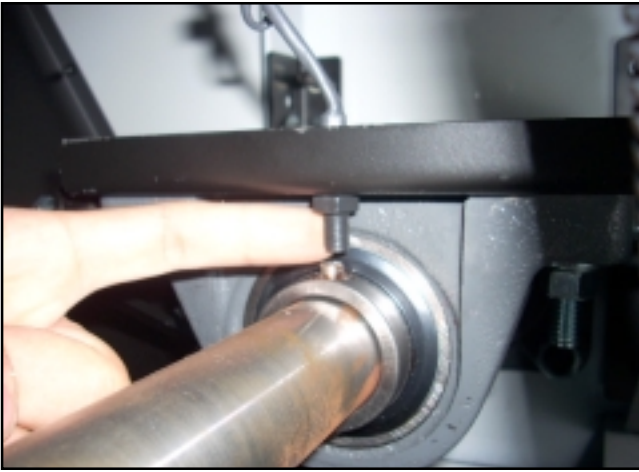

Remove the bottom nut on the rotation sensor. Lift the rotation sensor up and through the hole in the bearing box. Disconnect the rotation sensor two pin connector. Remove from the machine.

Basket/Tumbler Support Removal:



1. Remove lint screen assembly (refer to instructions).
2. Remove front panel assembly (follow "To Replace Front Panel Assembly").
3. Loosen setscrews on front tumbler bearing.

4. Using a wheel puller gently push the tumbler shaft towards the front through the front tumbler bearing.

NOTE: an alternate method would be to place a block of wood on the end of the tumbler shaft and strike it with a heavy hammer. To prevent damage to the shaft, the wheel puller method is preferred.

5. Remove the tumbler and support through the front of the dryer.
 - a. Remove the bolt in the center of the tumbler back wall.
 - b. Loosen and remove the nuts and washers from the tumbler tie rods. Remove the rods.
 - c. Replace either tumbler or tumbler support by reversing the procedure.
6. Reassemble components into dryer by reversing steps 1 through 4.
7. Check tumbler lateral and vertical alignment. Also, check belt tension and alignment.

NOTE: Check tension of belts and alignment of tumbler before operating dryer.

Check Tumbler Lateral and Vertical Adjustments:

3. Loosen the four hex head bolts on the sides of the bearing box (two on each side).
4. Back off jam nuts on the two Allen head adjustment screws.

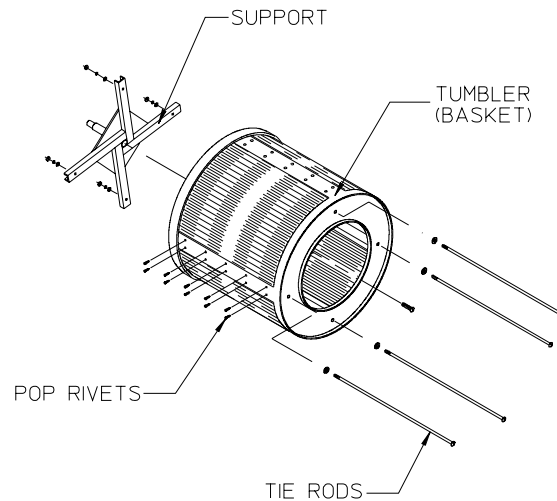

MAN0560

5. Turn the screws clockwise evenly to raise the tumbler or counterclockwise evenly to lower the tumbler.
6. Rotate the tumbler from the front and check alignment with the main door opening.
7. Leave a large gap from the inside ring on the top of the front panel opening to the tumbler, and a smaller gap on the bottom to compensate for the weight of the clothes drying.
8. Tighten the four hex head bolts on the sides of the bearing box, and the two Allen head adjustment screws.

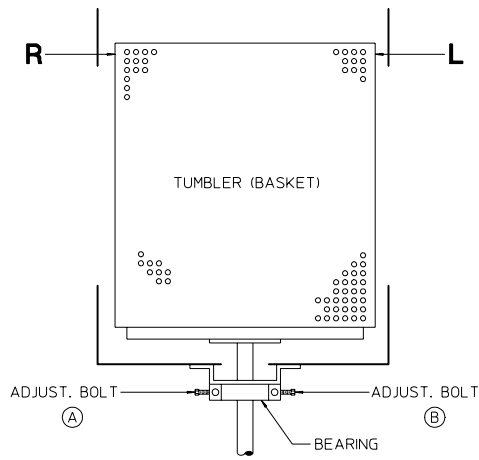

REAR OF DRYER

MAN0699

9. Replace back guard.
10. Reconnect power to dryer.

Tumbler Alignment (Lateral)

1. Discontinue power to the dryer.
2. Remove back guard.
3. Loosen the two hex head bolts, (one turn is enough), that holds the pillow block bearing to the bearing box.
4. Back off the two jam nuts on the side adjustment bolts. Now rotate the tumbler from the front of the dryer, checking the space between the tumbler and the front panel. This should be equal on the left-hand and right-hand side.
5. Lateral adjustment (viewing from the rear)
 - a. Loosening (by turning counterclockwise) the left-hand adjustment bolt and tightening (by turning clockwise) the right-hand adjustment bolt will shift the basket to the right.
 - b. Loosening (by turning counterclockwise) the right-hand adjustment bolt and tightening (by turning clockwise) the left-hand adjustment bolt will shift the basket to the left.
6. Tighten and secure both adjustment bolts and jam nuts.
7. Tighten the bearing box bolts.

Motor/Impellor Removal:



1. Remove back guard.
2. Remove drive belt.
3. Disconnect wiring harness from motor.

IMPORTANT: If top pocket is being replaced, ductwork on the side of the motor mount must be removed.

4. Remove nuts and washers holding the motor mount to the rear of the dryer and pull motor mount away.
5. Remove the two left-hand nuts on the motor shaft retaining the impellor. Work the impellor free from the motor shaft by means of a puller to prevent damage to the motor shaft.
6. Remove the bolts holding the motor and install on new motor.
7. Remove pulley from old motor and install on new motor.

